

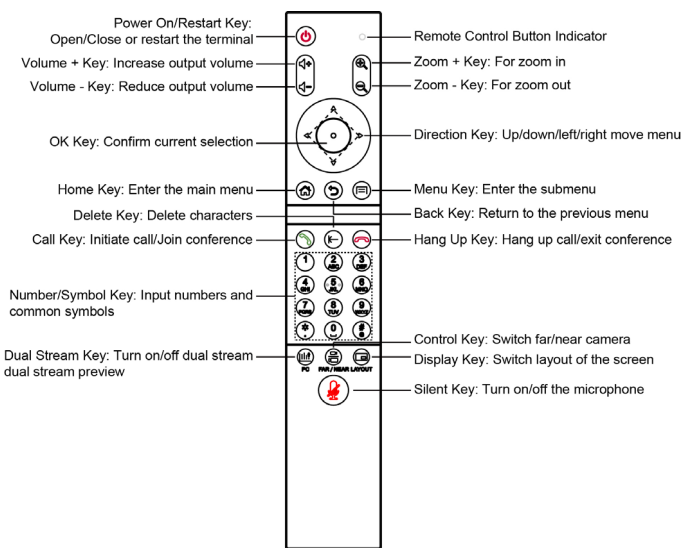

TP – 100 QUICK START GUIDE

1 Remote Control



The remote control may be affected by strong light, and the normal working distance is about ten meters.

2 GUI Main Interface

Press the home key “” of the remote control to enter the GUI main interface.

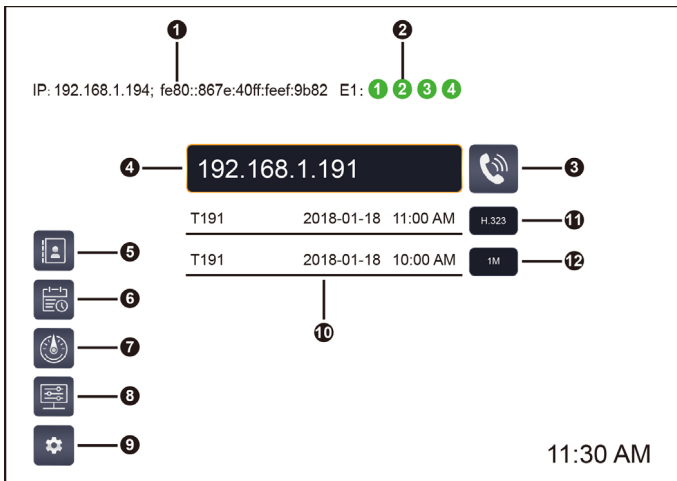



No.	Description	No.	Description
1	IPv4/IPv6 Address	2	E1 Channel Mark (only 2U device support)
3	Call Button	4	Remote IP or Number Input Box
5	Contacts Menu	6	History Menu
7	Diagnostic Menu	8	Control Menu
9	Settings Menu	10	Display Call History
11	Select Call Protocol	12	Select Call Rate

When you move the cursor to the “Settings” menu, the “Contacts”, “History”, “Diagnostic” and “Control” menus will pop up automatically; when you move the cursor to the “Call” button, the system will automatically pop up “Call Protocol” and “Call Rate” options boxes.

3 Hold the Meeting

Step 1 Enter the IP address or number of the remote meeting place in the input box.

Step 2 Select Call Protocol and Call Rate.

Step 3 Press the remote control “” call button to initiate a call. You can also press the arrow keys to move to the “Call” button on the interface, and then press the remote control “” confirm button to initiate the call.

Step 4 The E1 line can automatically initiate the call after it is properly connected (only 2U device support E1).



When the IP address or number of the remote site is already in the input box, press the remote control call button to initiate the call. You can also initiate a call from the historical call record.

4 Soft Keyboard Input



In the input box, press the remote control “” confirm button to input Chinese/English characters, special symbols, etc. through the soft keyboard.

5 Volume Adjustment

Press the “” volume button on the remote control to adjust the volume. When it is set to the minimum, the local speaker will be turned off.

6 Select and Control Camera



The local camera can be controlled using the remote control before the meeting starts and the menu interface is hidden. You can control the far end camera if the far end camera allows remote control during the conference.

Item	Instructions
Local/Remote Camera	Press the remote control “  ” control button to switch between local or remote camera.
Control Camera	<ul style="list-style-type: none"> Press the remote control's direction button to turn the camera. Press the remote control “” zoom button to zoom in or out of the image.

7 Switch the Screen Mode

Press the “” display button on the remote control several times to switch between screen-in-screen and other screen modes on the HDMI1 output screen.

8 Send the Second Video

Use DVI cable to connect device such as a computer to the DVI-I IN input of the terminal as the second video input. Press the “” dual stream button on the remote control and select “Open Dual Stream”, then press the remote control “” confirm button to send the video to the conference terminal.

9 End the Meeting

Press the remote control “” hang up button to end the meeting.